

特性

- 小型大容量继电器，最大切换负载40A
- 触点与线圈间耐压可达4000VAC
- 塑封型和防尘型可供选择
- 密封型和敞开型可供选择
- 外形尺寸：(32× 27.4× 19.7)mm

触点参数

触点形式	1A,1B or 1C
接触电阻	≤100mΩ (1A 6VDC)
触点材料	银合金
触点负载(阻性)	30A/40A 250VAC 40A 277VAC
最大切换额定电压	277VAC
最大切换额定电流	40A
最大切换额定功率	11080VA
机械耐久性	1,000,000次
电耐久性(阻性)	100,000次(1s通9s断)

性能参数

绝缘电阻	1000MΩ(500VDC)	
介质耐压	线圈与触点间	2500VAC/4000VAC 1min
	断开触点间	1500VAC 1min
动作时间(额定电压下)	≤15ms	
释放时间(额定电压下)	≤10ms	
抗振动	稳定性	10Hz ~ 55Hz 1.5mm
	强度	10Hz ~ 55Hz 1.5mm
抗冲击	稳定性	10G Min
	强度	100G Min
湿度	5% ~ 85%Rh	
温度范围	-40°C ~ 85°C	
引出端形式	PCB	
重量	约25g	

线圈规格表

温度：23°C

额定电压 (VDC)	额定电流 ±%(mA)	线圈电阻 ±10%(Ω)	最大连续外加电压	吸合电压 (Max)	释放电压 (Min)	线圈额定功率 (W)
5	180	27.78	额定电压的130%	额定电压的75%	额定电压的10%	0.9
6	150	40				
9	100	90				
12	75	160				
18	50	360				
24	37.5	640				
48	18.75	2560				
110	8.19	13444.45				
5	280	17.86	额定电压的130%	额定电压的75%	额定电压的10%	1.4
6	233.34	25.72				
9	155.56	57.86				
12	116.67	102.86				
18	77.78	231.43				
24	58.34	411.43				
48	29.17	1645.72				
110	12.73	8642.86				

安规认证

认证类别	CQC	TUV	UL
证书号	CQC09002029470	R 50163611	E321783
负载要求	30A 250VAC 2HP 250VAC 40A 250VAC	40A 240VAC cos phi=1(A型) 40A 14VDC L/R=0ms(A型) 30A 240VAC cos phi=1(B型) 30A 14VDC L/R=0ms(B型) NO/NC:40A/30A 240VAC cos phi=1 NO/NC:40/30A 14VDC L/R=0ms	40A 277VAC(1form A) 1.5HP 277VAC(1form A) 2HP 240VAC(1form A) 30A 277VAC(1form B,1form C,NC) 30A 125/250/277VAC(1formA,1formC,NO) TV-5 120VAC(1formC,NC,1formB) TV-10 120VAC(1formC,NO,1formA)

GK-C 命名规则

GK-C -1C -12 D H G A D C F XXX

特殊说明：字母或数字--特殊说明，
T--环境温度105°C

绝缘等级：无--130°C；F--155°C

密封方式：无--塑封防尘型；C--全密封型；S--防爆型

IP/OP耐压强度：无--≥2500V；D--≥4000VAC

端脚吊孔形式：无--标准吊孔；A--大吊孔；B--无吊孔

触点间隙 (GAP)：无--标准型；G--GAP≥1.5mm(适用于1.4W)

触点负载：无--30A；H--40A

线圈功率：D--0.9W；D3--1.4W

线圈额定电压 (VDC)：5, 6, 9, 12, 18, 24, 48, 110

触点形式：1A--1组常开型；1B--1组常闭型；1C--1组转换型

型号：GK-C

外形图

单位:mm

常规吊孔

大吊孔

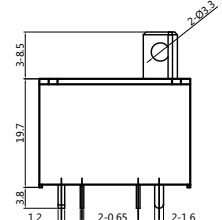
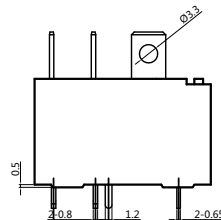
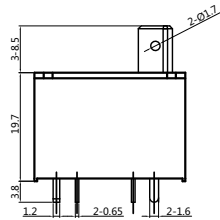
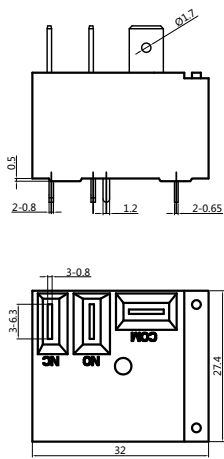

注：产品部分外形尺寸未注尺寸公差，当外形尺寸 < 1mm，公差为±0.2mm；
当外形尺寸在1~5mm之间时，公差为±0.3mm；当外形尺寸 > 5mm，公差为±0.4mm。

接线图

单位:mm

GK-C-1A

GK-C-1B

GK-C-1C

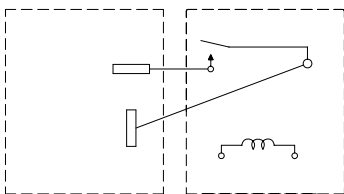

顶视图 底视图

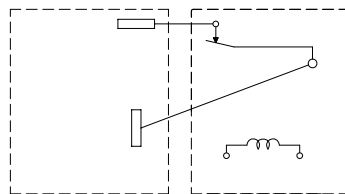

顶视图 底视图

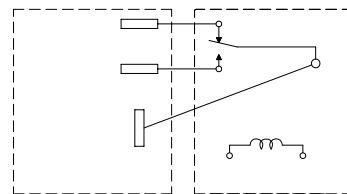

顶视图 底视图

安装孔尺寸图 (底视图)

单位:mm

GK-C-1A

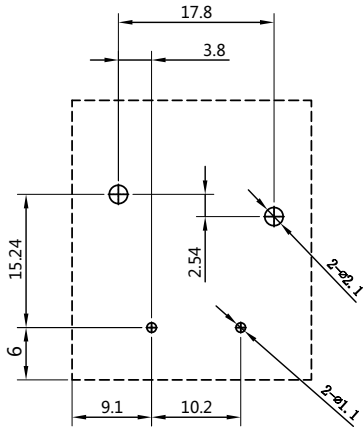

GK-C-1B

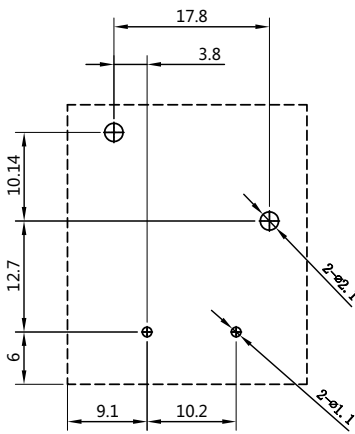

GK-C-1C

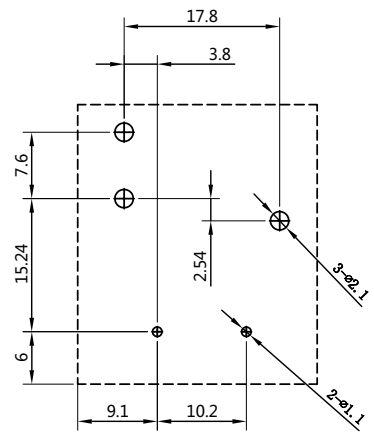

注：引出端子尺寸为预焊前尺寸；安装孔尺寸公差：±0.1mm。

性能曲线图

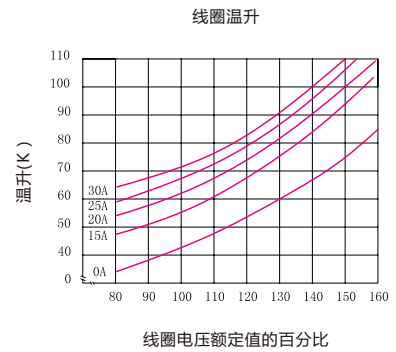
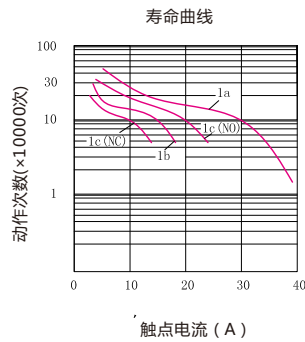
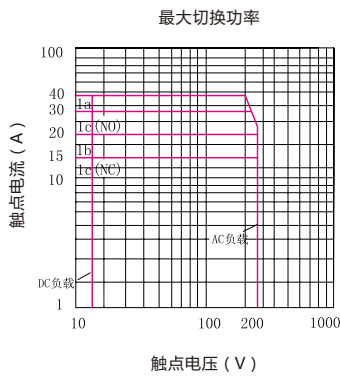

声明:

本产品规格书仅供客户使用时参考,若有更改,恕不另行通知。

对高登而言,不可能评定继电器在每个具体应用领域的所有性能参数要求,因而客户应该根据具体的使用条件选择与之相配的产品,若有疑问,请与高登联系获取更多的技术支持,但是产品选型责任由客户负责。

©深圳高登电科技股份有限公司版权所有,本公司保留所有权利。



Characteristics

- 40A contact switching capability
- Withstand voltage between contact and coil can reach 4000VAC
- Dimensions: (32× 27.4× 19.7) mm

Contact parameter

Contact form	1A,1B or 1C
Contact resistance	≤100mΩ(1A 6VDC)
Contact material	Silver alloy
Contact load (resistance)	30A/40A 250VAC 40A 277VAC
Maximum switching rated voltage	277VAC
Maximum switching current rating	40A
Maximum switching power rating	11080VA
Mechanical durability	1,000,000 times
Electrical durability(resistive)	100,000次 times (1s on 9s off)

Performance parameter

Insulation resistance	1000MΩ(500VDC)	
Dielectric withstand voltage	Coil and contact	2500VAC/4000VAC 1min
	Disconnect the contacts	1500VAC 1min
Operating time (at rated voltage)	≤15ms	
Release time (at rated voltage)	≤10ms	
Vibration resistant	Malfunction	10Hz~55Hz 1.5mm
	Durability	10Hz~55Hz 1.5mm
Impact resistance	Malfunction	10G Min
	Durability	100G Min
humidity	5%~85%Rh	
temperature range	-40°C~85°C	
Terminal form	PCB	
weight	About 25g	

Coil parameter			Temperature: 23°C			
Nominal Voltage (VDC)	Rated current ±%(mA)	Coil resistance ±10%(Ω)	Maximum continuous applied voltage	Pull-in voltage (Max)	Release voltage (Min)	Coil rated power (W)
5	180	27.78	130% of rated voltage	75% of rated voltage	10% of rated voltage	0.9
6	150	40				
9	100	90				
12	75	160				
18	50	360				
24	37.5	640				
48	18.75	2560				
110	8.19	13444.45	130% of rated voltage	75% of rated voltage	10% of rated voltage	1.4
5	280	17.86				
6	233.34	25.72				
9	155.56	57.86				
12	116.67	102.86				
18	77.78	231.43				
24	58.34	411.43				
48	29.17	1645.72				
110	12.73	8642.86				

Safety certification			
Certification category	CQC	TUV	UL
Certificate No	CQC09002029470	R 50163611	E321783
Load requirement	30A 250VAC 2HP 250VAC 40A 250VAC	40A 240VAC cos phi=1(A型) 40A 14VDC L/R=0ms(A型) 30A 240VAC cos phi=1(B型) 30A 14VDC L/R=0ms(B型) NO/NC:40A/30A 240VAC cos phi=1 NO/NC:40/30A 14VDC L/R=0ms	40A 277VAC(1form A) 1.5HP 277VAC(1form A) 2HP 240VAC(1form A) 30A 277VAC(1form B,1form C,NC) 30A 125/250/277VAC(1formA,1formC,NO) TV-5 120VAC(1formC,NC/1formB) TV-10 120VAC(1formC,NO,1formA)

GK-C naming rules

GK-C	-1C	-12	D	H	G	A	D	C	F	XXX
Special instructions: letters or numbers-special instructions, T--Ambient temperature 105°C										
Insulation class: Blank--130°C ; F--155°C;										
Sealing method: Blank--plastic sealed dust-proof type; C--fully sealed type; S--explosion-proof type										
IP/OP compressive strength: Blank--≥2500V; D--≥4000VAC										
End foot lifting hole: Blank--standard lifting hole; A--large lifting hole; B--no lifting hole										
Contact gap (GAP): Blank--standard type; G--GAP≥1.5mm (applicable to 1.4W A type)										
Contact load: Blank--30A; H--40A										
Coil power: D--0.9W; D3--1.4W										
Coil rated voltage (VDC): 5, 6, 9, 12, 18, 24, 48, 110										
Contact form: 1A--1 group normally open; 1B--1 group normally closed; 1C--1 group conversion										
Model: GK-C										

Outline drawing

Unit: mm

Standard lifting hole

Big hanging hole

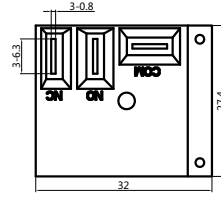
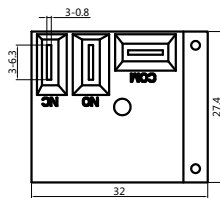
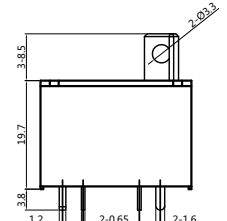
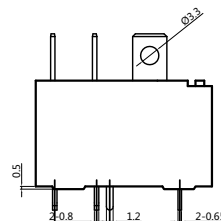
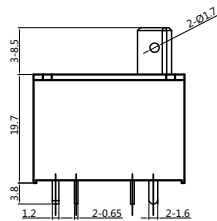
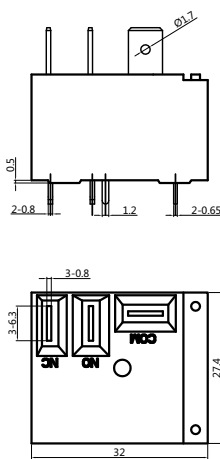

Note: Part of the product has no tolerances on the external dimensions.
 When the external dimensions are less than 1mm, the tolerance is ±0.2mm;
 When the external dimension is between 1~5mm, the tolerance is ±0.3mm;
 When the external dimension >5mm, the tolerance is ±0.4mm.

Wiring diagram

Unit: mm

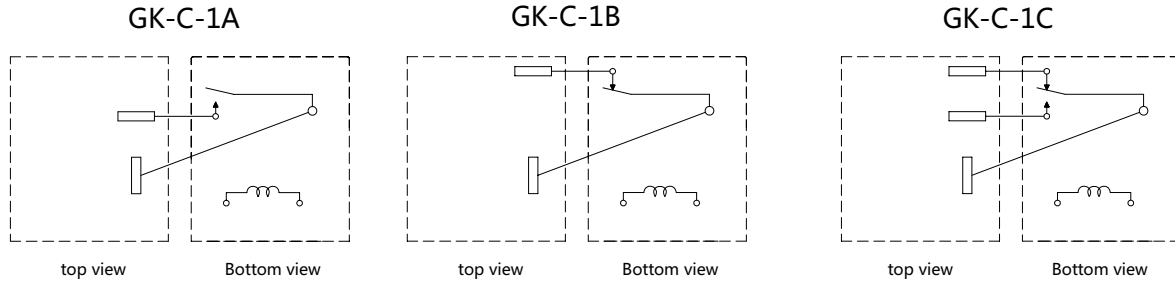

Mounting hole size (bottom view)

Unit: mm

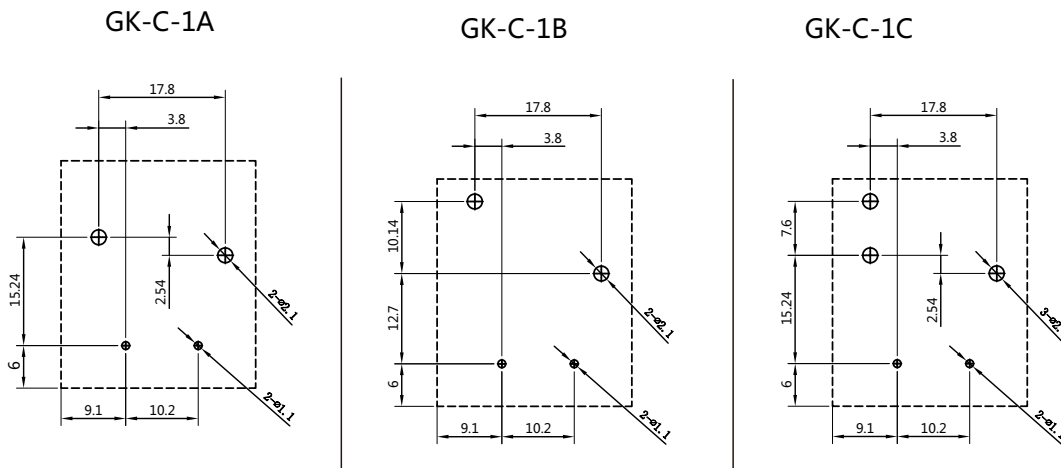

Note: The size of the lead terminal is the size before pre-welding; the size tolerance of the mounting hole: $\pm 0.1\text{mm}$.

Performance graph

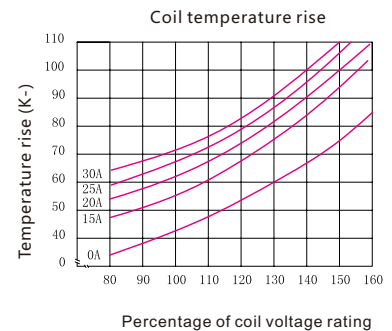
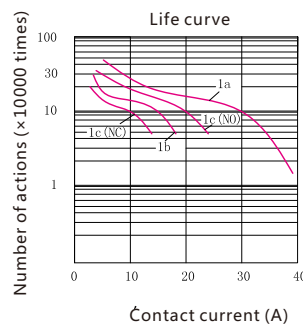
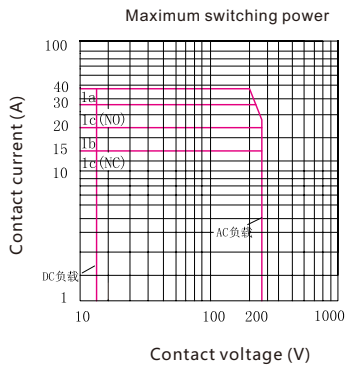

statement:

This product specification is only for reference when customers use it, and subject to change without notice.

For Gordon, it is impossible to evaluate all the performance parameter requirements of the relay in each specific application field. Therefore, the customer should choose the product that matches it according to the specific use conditions. If you have questions, please contact Gordon for more technical support, but the customer is responsible for product selection.

©Shenzhen Gordon Electronics Co., Ltd. All rights reserved. All rights are reserved by the company.